











Features:

- Caller ID display – displays 199 caller ID's in FSK and DTMF and displays name in English.
- Hearing aid compatible handset.
- Data port.
- Service buttons.
- R button activates the PBX flash function. The default is 100ms.
- Redial button redials the last number dialled.
- Speaker button with indicator.
- **PROG** button – programmes the service buttons.
- **VOL** button adjusts handset and speaker volume.
- Message and ringing indicator.
- Programme service button with R.P master cloner and handheld cloner.
- Pre-dial function.
- Desktop and wall mounting.

CONTROLS AND FUNCTIONAL KEYS

Features Description of the functional keys

-  - Microphone switch (handset).
-  - Signalling the PBX to activate the flash function. The default is 100ms.
-  - Redial button.
-  - For "On-hook" dialling (speaker phone mode).
-  - For programming.
-  - Various functions.
-  - To adjust ringer volume of handset and speaker.
-  - Key for special services.
-  - Key for special services.

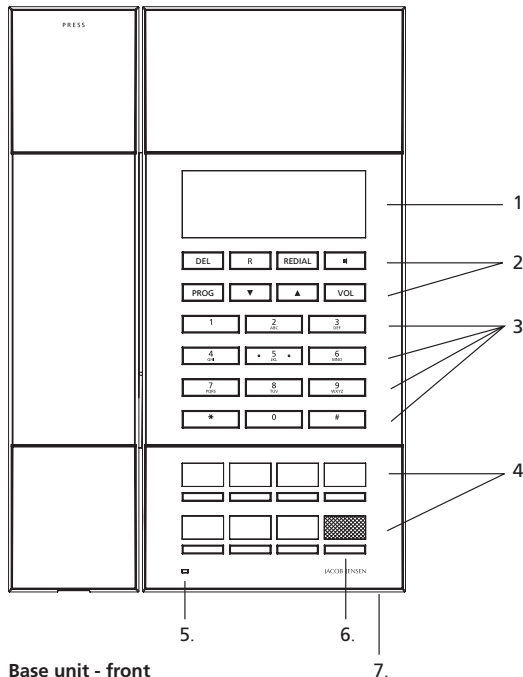

Base unit - front

1. LCD screen display
2. 8 functional keys
3. 12 numerical keys
4. Service buttons
5. Indicator (LED)
6. Message waiting indicator (MWI)
7. Hands-free microphone

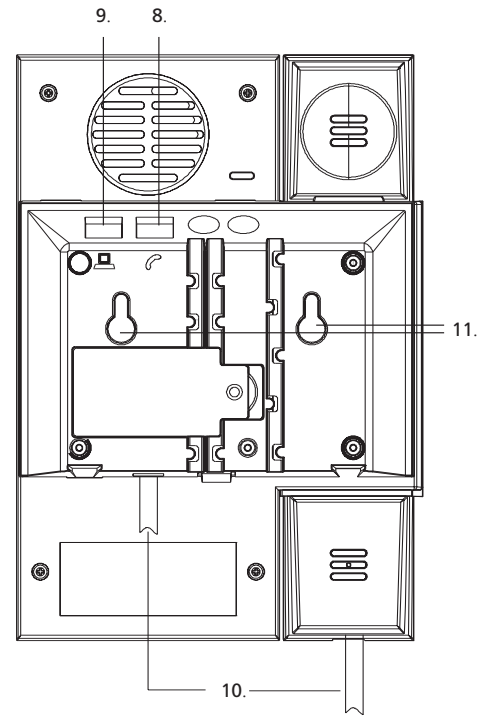

Base unit - rear

8. Telephone line jack
9. Data port
10. Handset cord jack
11. Holes for wall mounting

Material:	ABS, PMMA.
Colours:	Anthracite with silver coloured plates.
Approved standards:	EN 55022 and EN 55024.